

Hudson Reed

1-Loch Einhebel-Waschtischarmatur

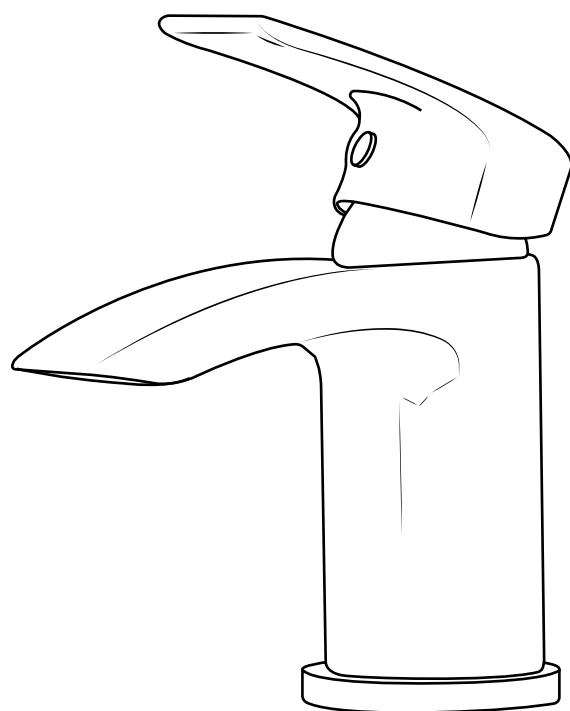

Installationsanleitung

Installation

Benötigtes Werkzeug:

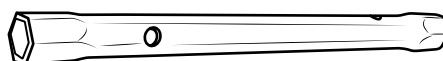
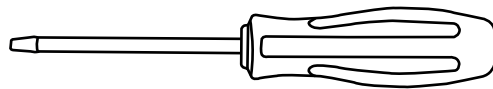
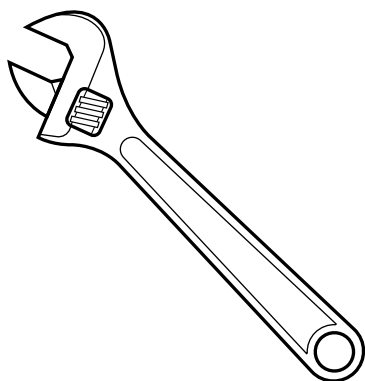

Im Lieferumfang:

 Stil kann abweichen

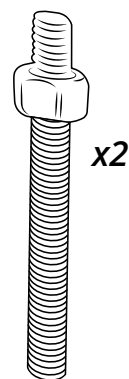
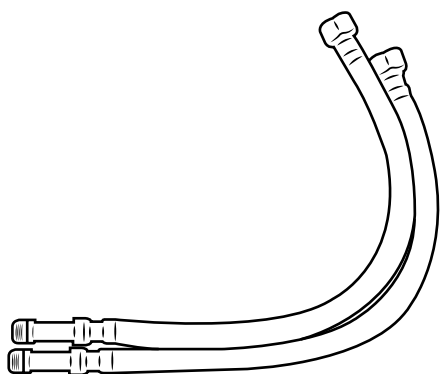
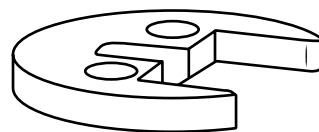
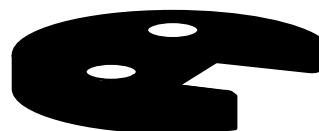
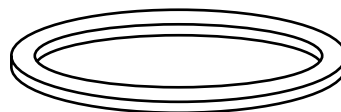
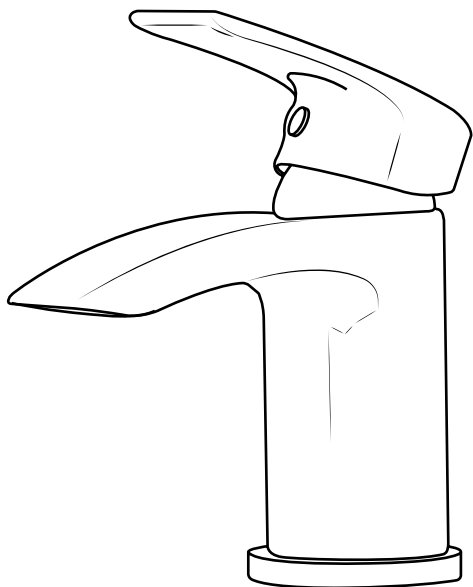

1

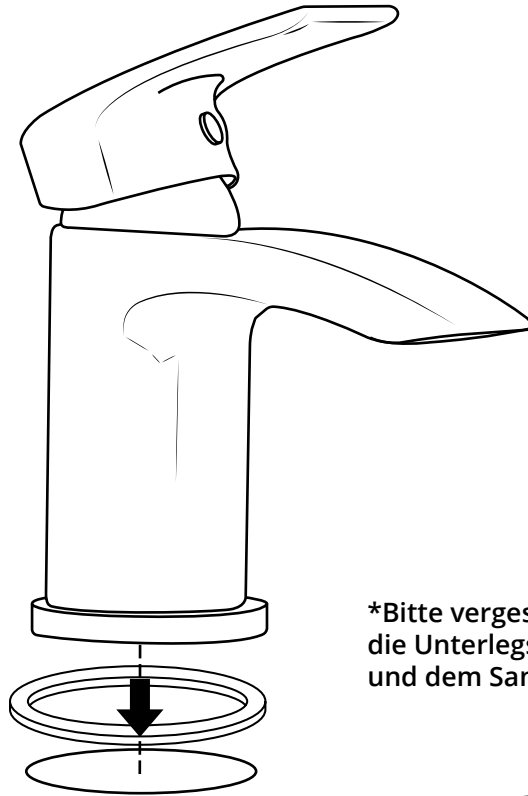

Bitte vergessen Sie nicht, den O-Ring oder die Unterlegscheibe zwischen der Armatur und dem Sanitärartikel anzubringen.

2

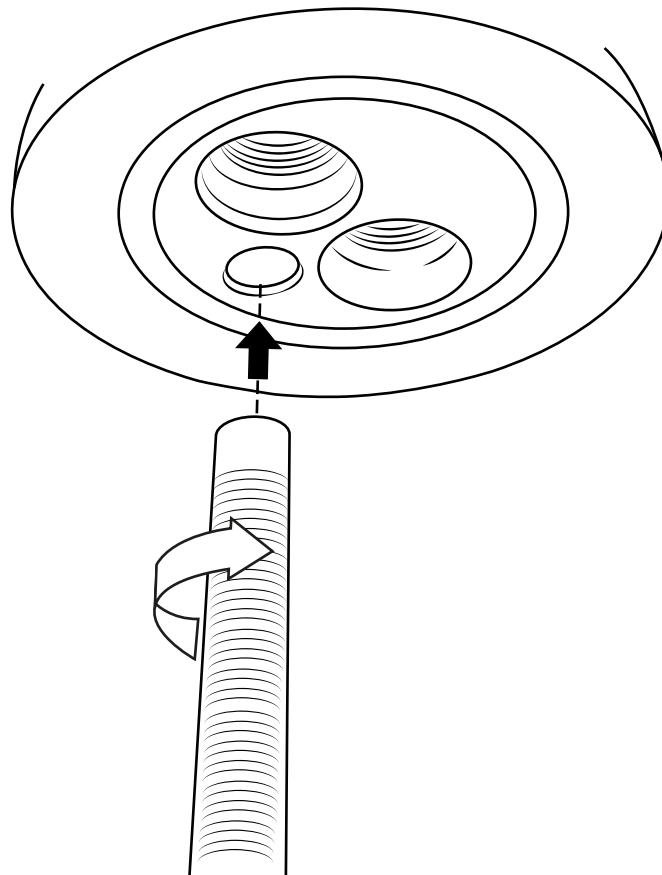

3

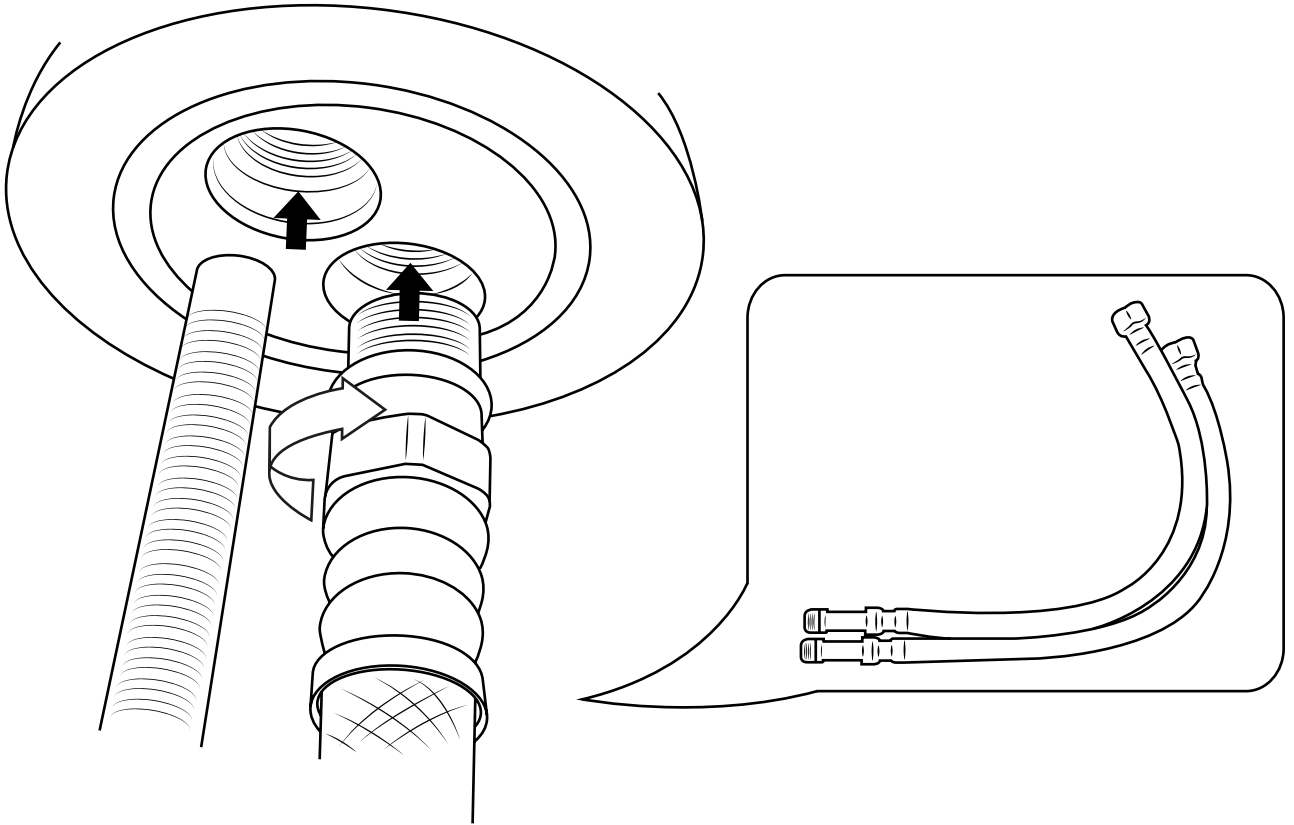

4

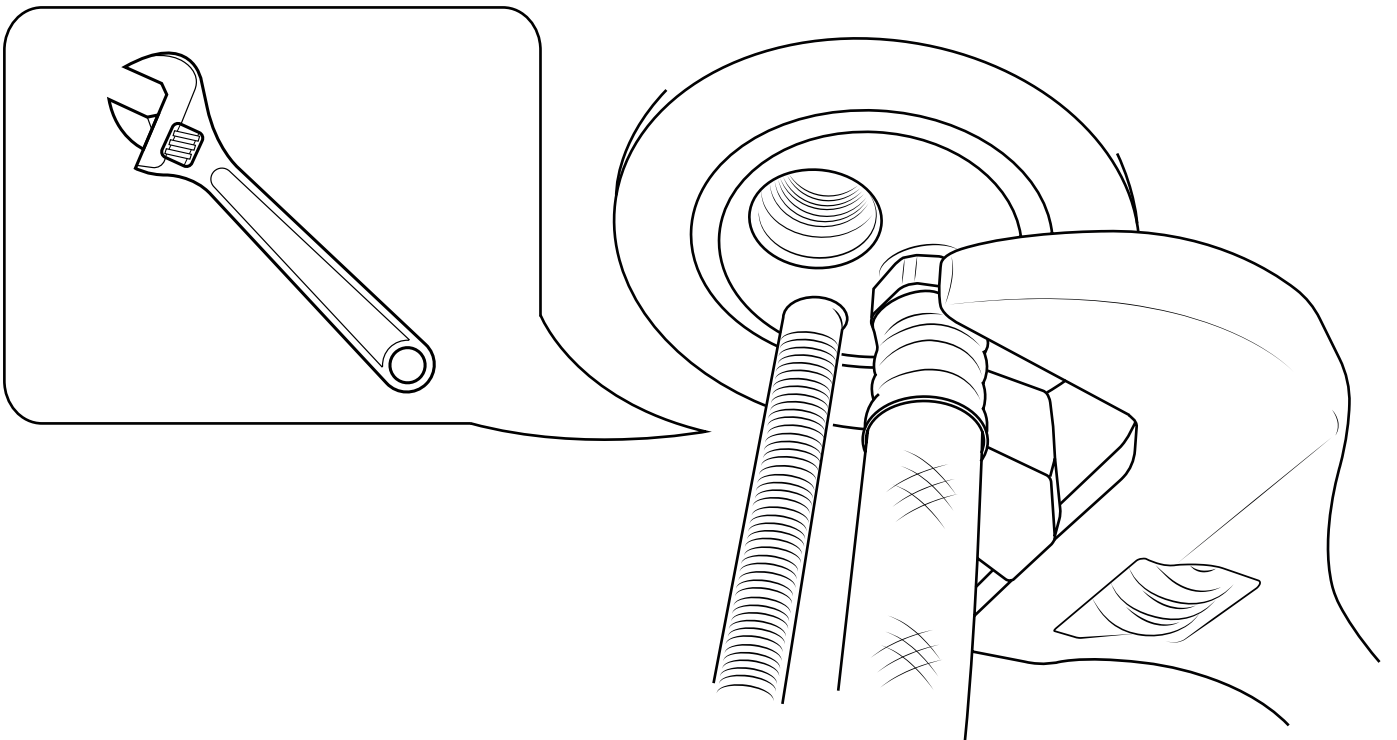

5

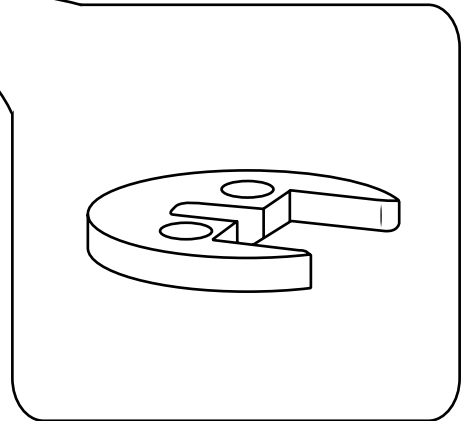
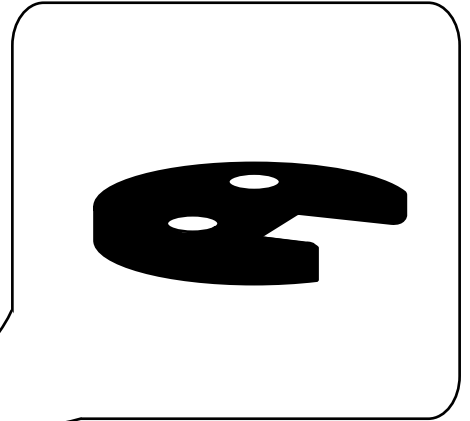
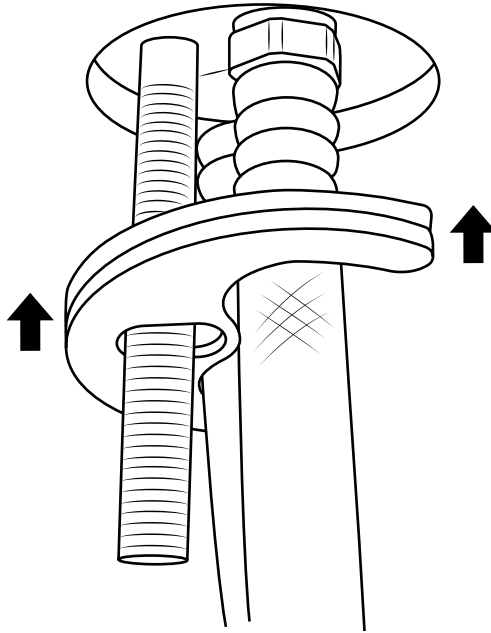
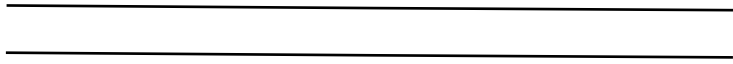

6

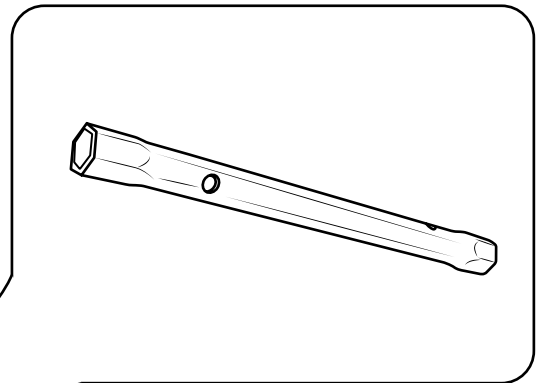
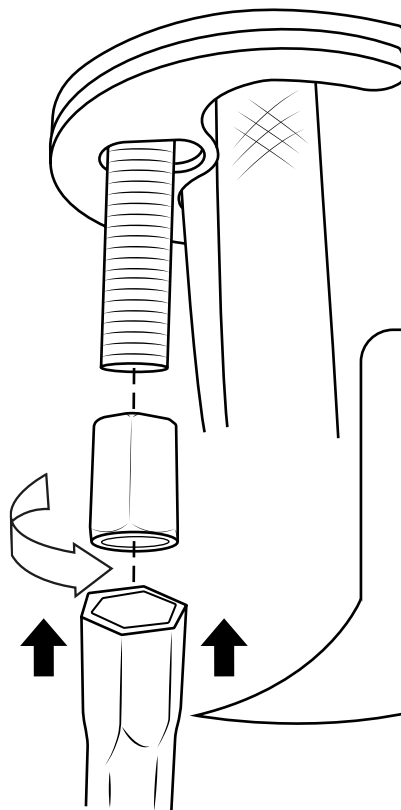
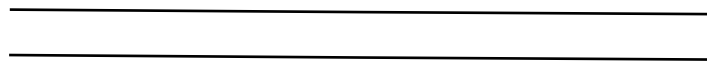

7

